	_ _ _ _ _		

	1
	2

	<p data-bbox="427 232 453 268">1</p> <p data-bbox="427 1659 453 1695">2</p>
--	---

	1-2							

1-3		
<hr/>		

1-5

2020 49

	<p data-bbox="389 360 405 383">1</p> <p data-bbox="389 1294 405 1317">2</p>
--	---

7

2-1

t/a

8

	9

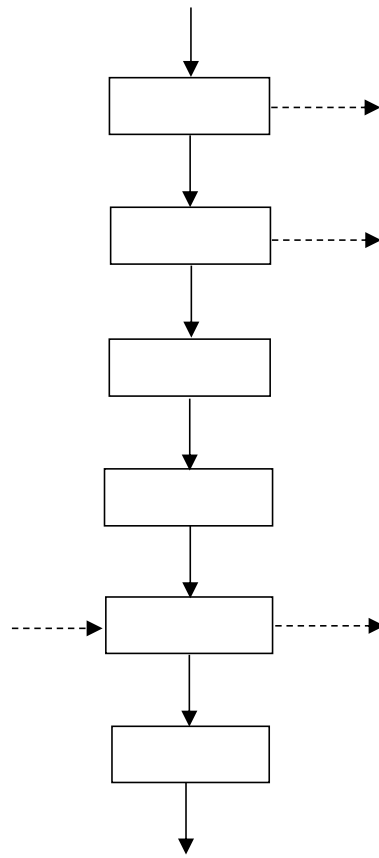

2-1

1

3-1

		$\mu\text{g}/\text{m}^3$	$\mu\text{g}/\text{m}^3$	%	

3-2

--	--	--	--	--	--

2

3

3-3

		°							
									m
	/	/	/	/	/	/	/	/	/

UTM

3-4

3			
3-7			
	dB A	dB A	
4			

	<p>1</p> <p>1</p> <p>4-1</p> <table border="1"> <thead> <tr> <th></th> <th>(m³/h)</th> <th></th> <th colspan="3"></th> <th></th> <th>(%)</th> <th colspan="3"></th> <th>(m)</th> <th></th> </tr> <tr> <th></th> <th>(m³/h)</th> <th></th> <th>(mg/m³)</th> <th>(kg/h)</th> <th>(t/a)</th> <th></th> <th>(%)</th> <th>(mg/m³)</th> <th>(kg/h)</th> <th>t/a</th> <th>(m)</th> <th></th> </tr> </thead> <tbody> <tr> <td></td> <td></td> <td></td> <td></td> <td></td> <td></td> <td></td> <td></td> <td></td> <td></td> <td></td> <td></td> <td></td> </tr> </tbody> </table> <p>2</p>		(m ³ /h)						(%)				(m)			(m ³ /h)		(mg/m ³)	(kg/h)	(t/a)		(%)	(mg/m ³)	(kg/h)	t/a	(m)														
	(m ³ /h)						(%)				(m)																													
	(m ³ /h)		(mg/m ³)	(kg/h)	(t/a)		(%)	(mg/m ³)	(kg/h)	t/a	(m)																													

4-2

			/				
			t/a	m	m	m	kg/h

3

4-3

mg/ m³ kg/ h t/a



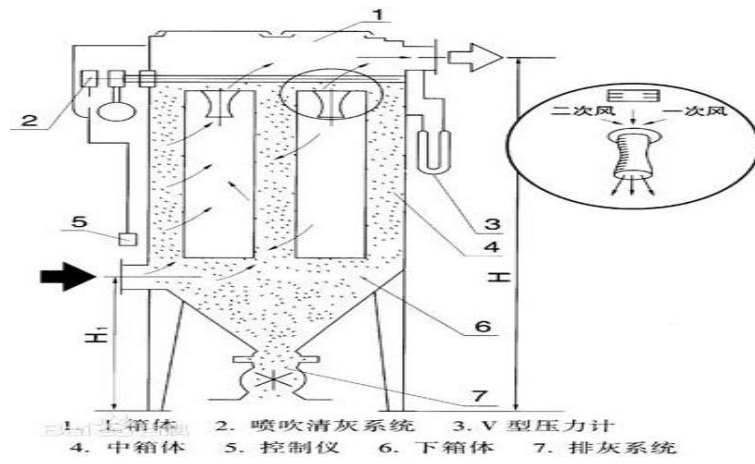

4-2

5

4-4

	m	m	m ³ /h	m/s	

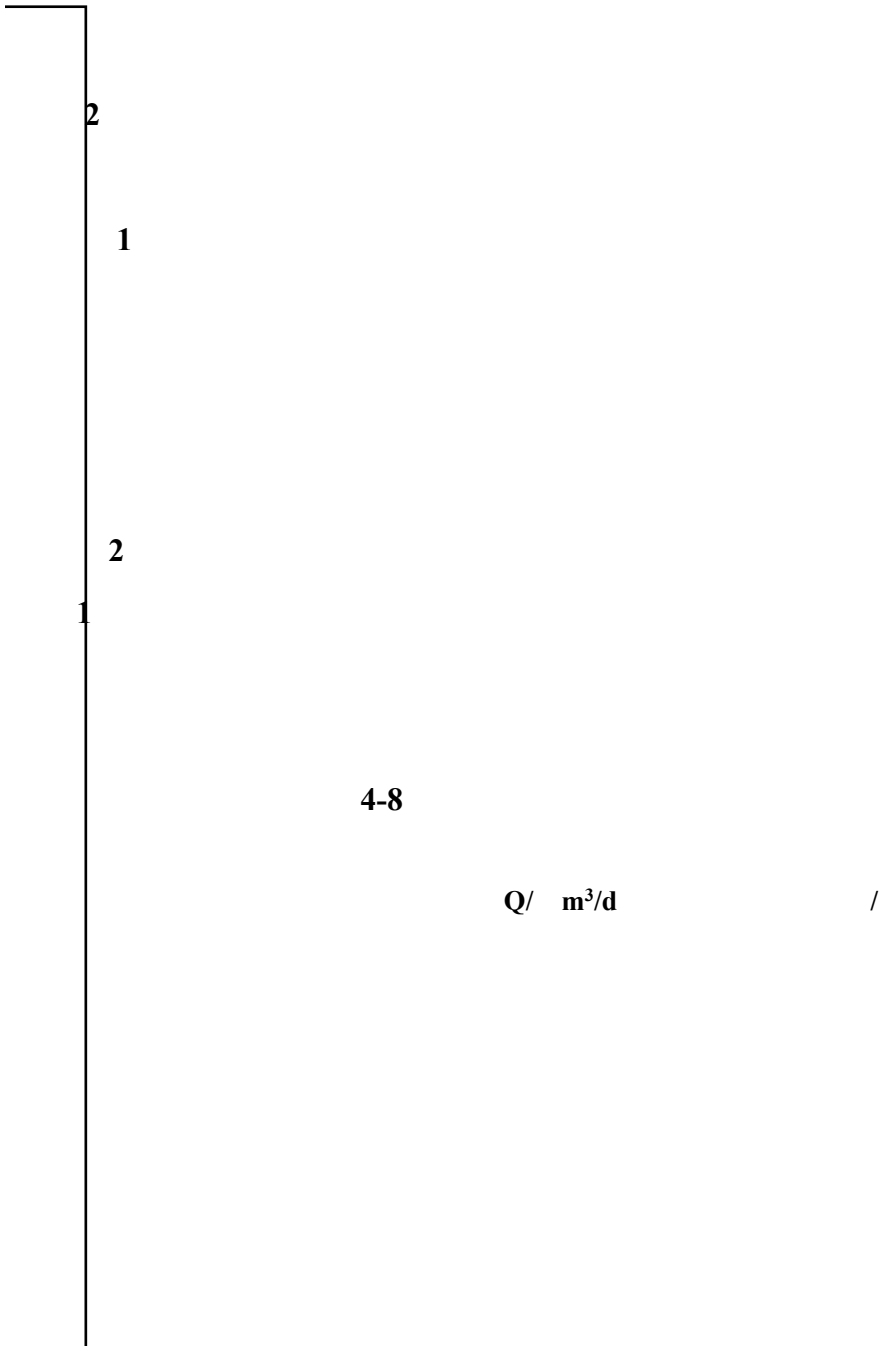
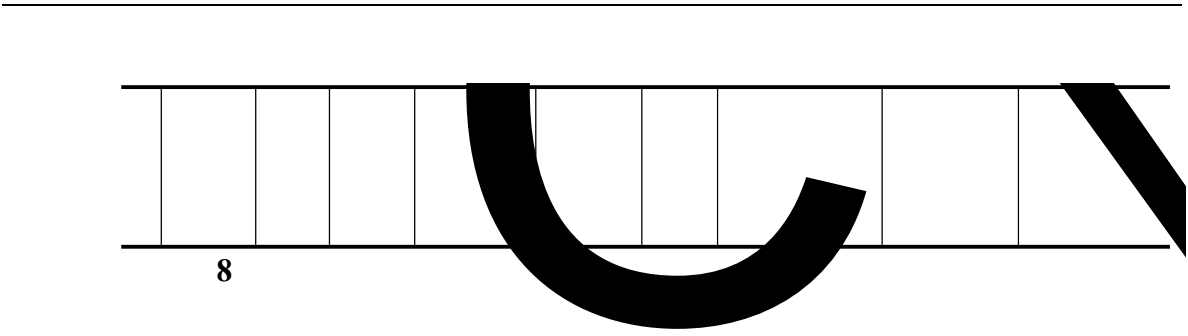

2

4-9

	m	m	m	
--	----------	----------	----------	--

3

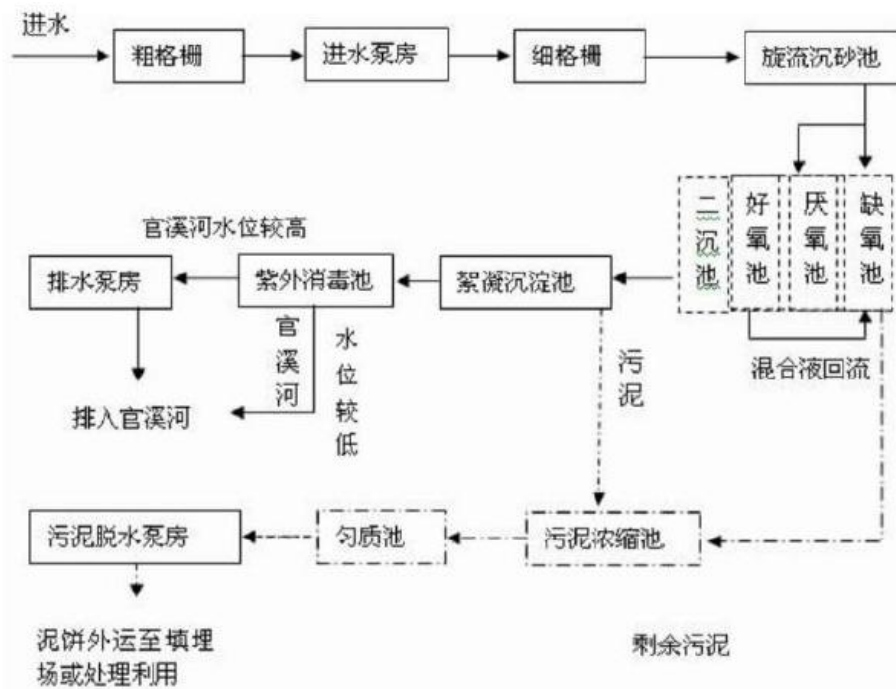

4-3

--	--	--	--	--	--	--	--	--	--	--	--

3

$$= \quad -$$

$$= \left[\sum_{=} \right]$$

4-14

dB A

				dB(A)	dB(A)	
	4					
	1					

4-15

					t/a			

4-16

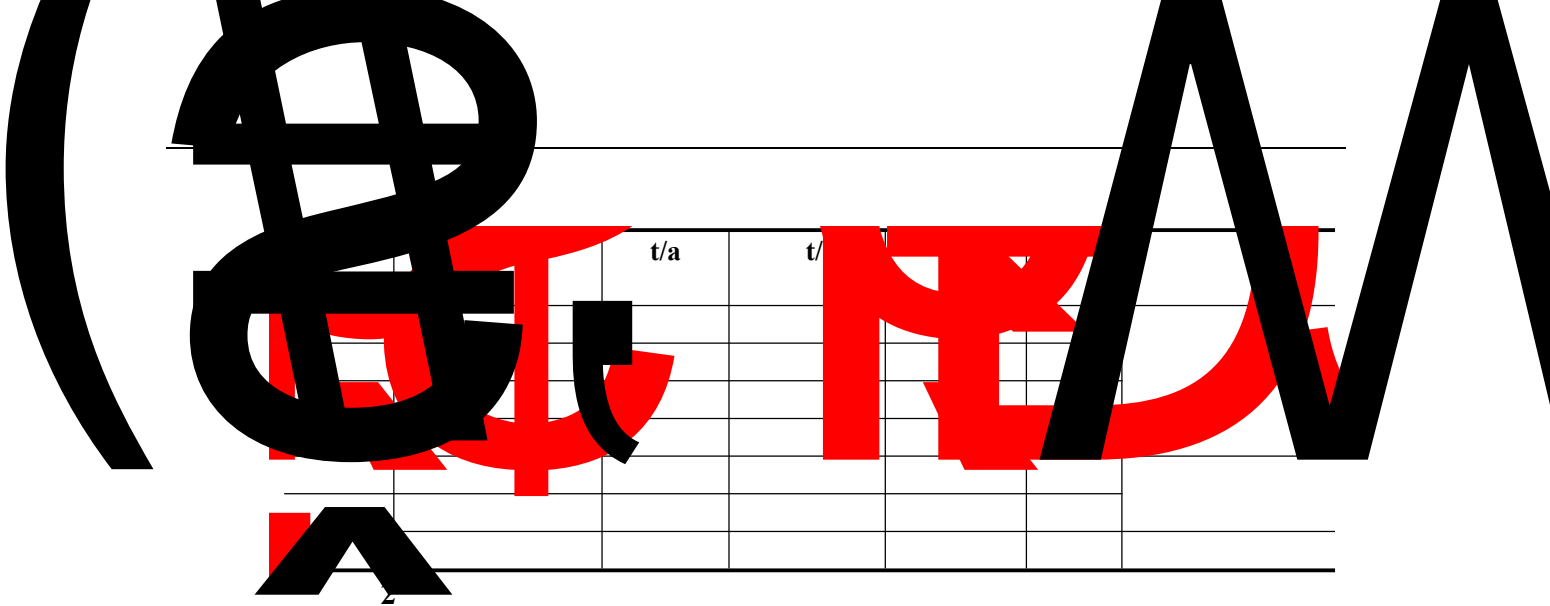

1

Ã

x

Ä:LEO@ñ8\$ P €,2"

2

ME *e0 ð. W.

ËP@ñ0 ‡YF 0â +O+O

E 4

PËY F5P2º

È ¤:U Ox\$5

*Ë:π O



4-18

					t/a						

GB18599-2020

4-20

4-21

2019 327

4-22

5

4-23

	4-23								

2

3

4-24

4

6

7

1

4-25

E	P			
	P1	P2	P3	P4

$$= \text{---} + \text{---} + \text{---}$$

4-26

	qi	Qi		qi/Qi

2

4-27

	IV IV⁺	III	II	I

3







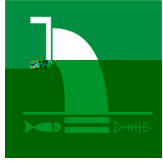

	4
--	---

--	--

	<p data-bbox="406 1099 432 1133">4</p>
--	--

--	--

	()			

				
				
				
				
				
	2	5-3	5-3	
		5-3	“ ”	

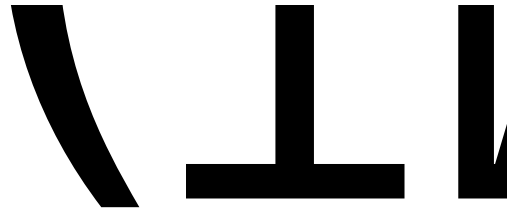

Ä

